



RIDG-U-RAK



Pallet Rack Storage Systems



Ridg-U-Tier II Pallet Racks

Ridg-U-Tier II is the only rack offering you this unique combination of features.

- Larger foot pad
- Tear-drop design
- Forest green finish
- Heavier bracing
- Bigger columns than others
- Optional 3-pin connection
- Complete range of rack accessories
- Unique center reinforcing rib
- Economical one-piece beams
- Adjustable in 2 inch increments
- Impact reinforcing available

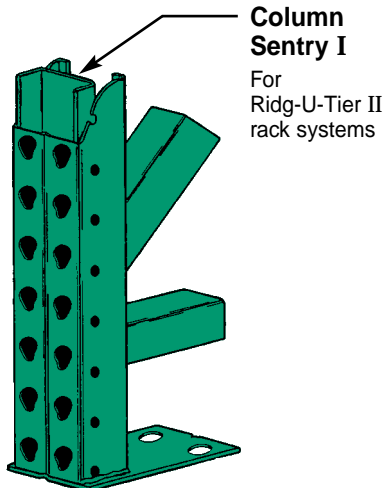
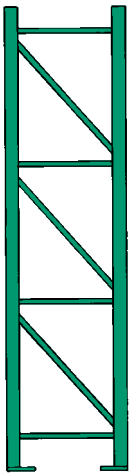

Upright frame numbering system

Example:

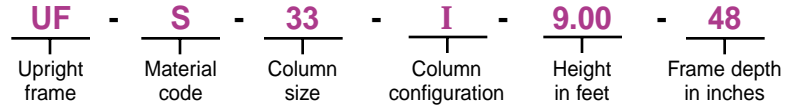

Upright frame capacities

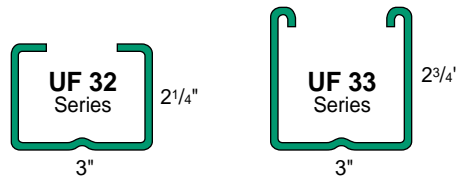

Note: The deeper column sections add extra impact resistance and capacity.

Frame capacity

The Frame Capacity Chart gives allowable loads based on the specified **unsupported length** of the column.

The loads on upright frames accumulate from top to bottom; therefore, the **unsupported length** and the column load below each beam level should be checked to determine the worst-case combination.

Frame capacity chart

Maximum Vertical Beam Spacing	32-I			33-I			43-I
	S	M	H	S	M	H	M
36"	23,100	29,800	36,100	27,900	38,800	47,000	47,900
44"	21,300	27,400	33,200	25,700	35,600	43,000	45,700
48"	20,300	26,100	31,500	24,600	33,800	40,900	44,500
52"	19,200	24,700	29,700	23,300	31,900	38,600	43,100
60"	17,000	21,700	26,100	20,700	28,100	33,900	40,200
72"	13,500	17,200	20,600	16,600	22,300	26,800	35,300
84"	10,400	13,300	15,800	12,900	17,200	20,700	30,200
96"	8,300	10,500	12,500	10,300	13,500	16,300	25,200
108"	6,700	8,500	10,100	8,300	10,900	13,100	20,500

Vertical beam to beam spacing greater than 108" consult factory



Ridg-U-Tier II Beams

Ridg-U-Rak offers many standard beam models, in virtually any length, with capacities to 22,500 lbs. per pair plus interchangeability. Tie into many existing systems, both old and new designs.

Beams have a safety factor of 1.67 based on minimum yield of steel. All beams are painted Safety Orange as standard. Special finishes, such as non-standard colors or galvanizing, are available on special order.

Beam welding is full penetration continuous welds to the end plate - not spot or tack welds.

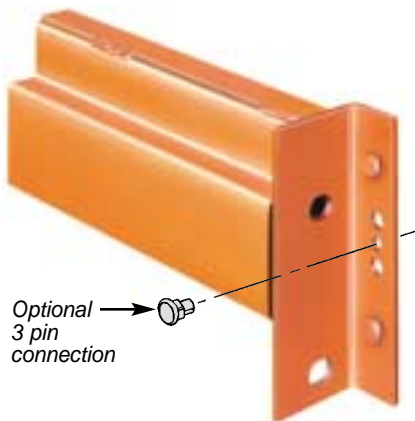

Electrostatically coated Safety Orange paint finish on Ridg-U-Rak beams gives your operators added visual assistance in loading or unloading racks.

- All beam capacities are calculated based on the requirements of the 1997 RMI specification. Deflection is limited to not exceed length/180 in all instances.
- Beams listed here represent popular sizes and only a portion of the thousands of sizes available. Ridg-U-Rak beams are available in any height or length you need.
- All capacities are based on **uniformly distributed loads** on a pair of beams. Other loading conditions can greatly reduce the carrying capacities of the beams. For unusual loading requirements, call your local Ridg-U-Rak distributor.

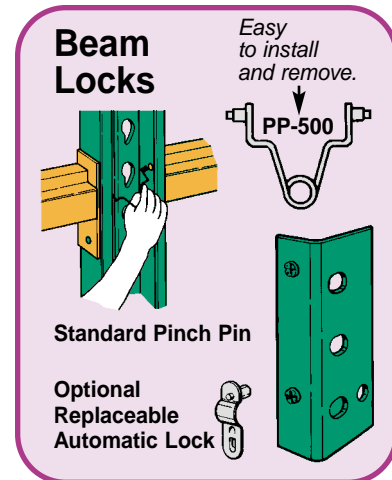

Beam dimensions

Part Number	X
RB-L-32I-300	3.00
RB-L-32I-355	3.55
RB-S-32I-355	3.55
RB-L-32I-410	4.10
RB-S-32I-450	4.50
RB-L-32I-465	4.65
RB-S-32I-500	5.00
RB-S-32I-600	6.00

Beam length determination

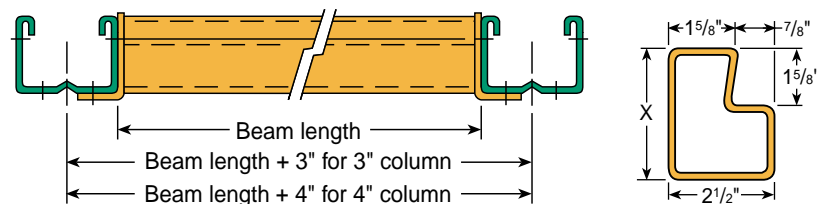

Beams capacities

Max. capacities in pounds per pair of beams - no values exceed L/180 deflection. Many other beam capacities and sizes available - consult factory.

Part Number	Beam Lengths								
	48"	60"	72"	84"	96"	108"	120"	132"	144"
300 L	6440	5130	4200	3070	2340	1850	1490	1230	1030
355 L	8350	6650	5520	4630	3530	2780	2250	1850	1550
355 S	9590	7640	6340	5250	4010	3150	2550	2100	1760
410 L	10490	8360	6940	5930	5060	3990	3220	2650	2220
450S			10250	8760	7640	6260	5060	4170	3490
465 L			8480	7250	6320	5480	4420	3650	3060
500 S			11940	10200	8900	7890	6580	5420	4550
600 S			14750	12600	10990	9750	8750	7940	6670

High Performance and Ridg-U-Tier II Accessories

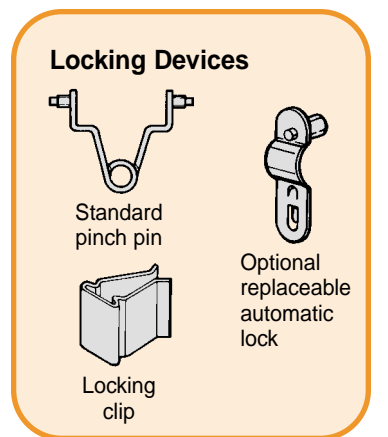
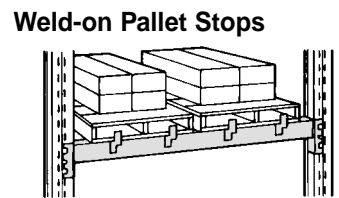
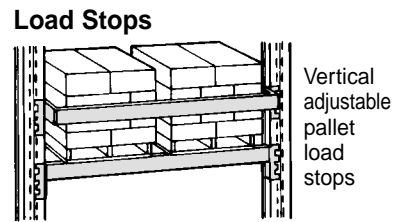
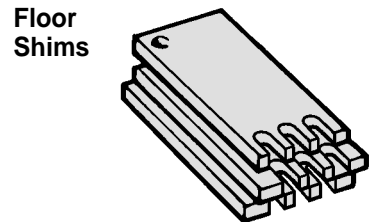
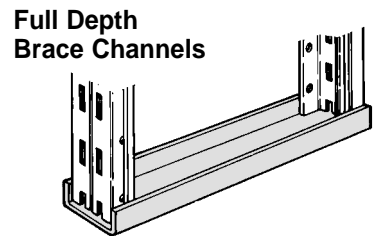
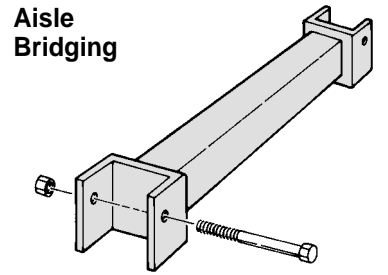
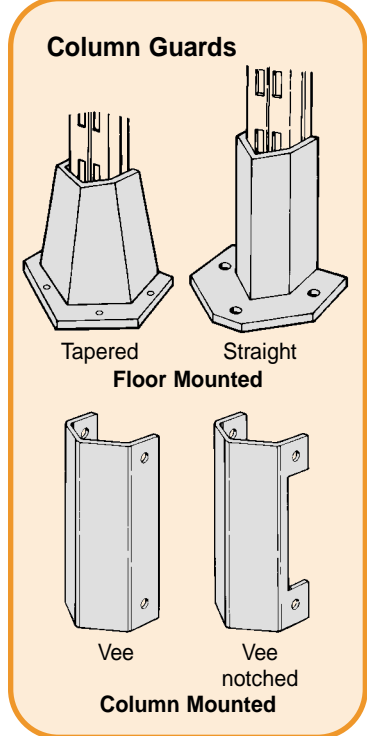
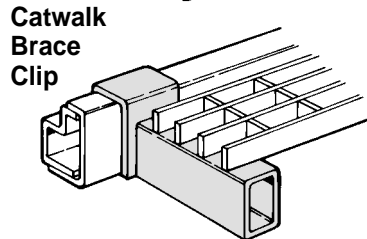
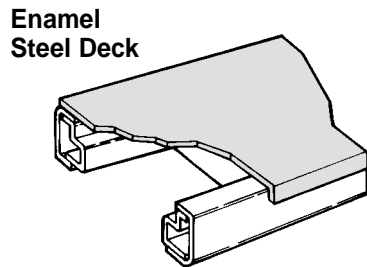
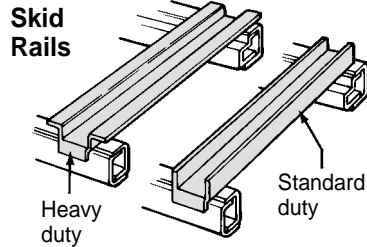
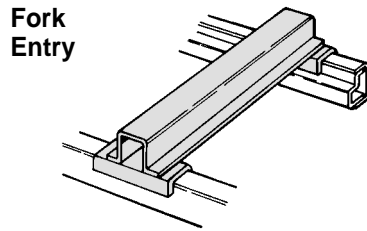
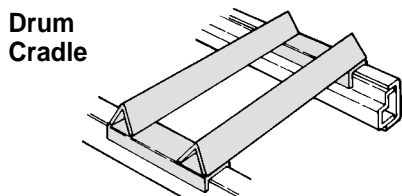
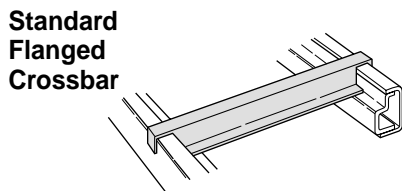
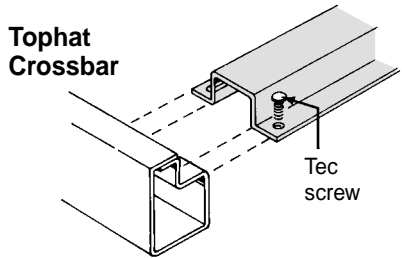
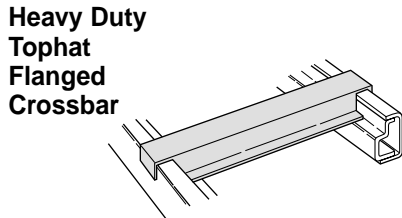
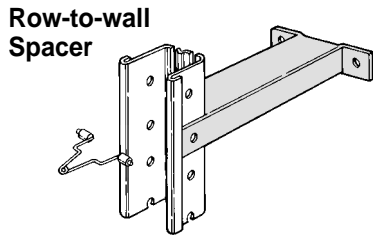
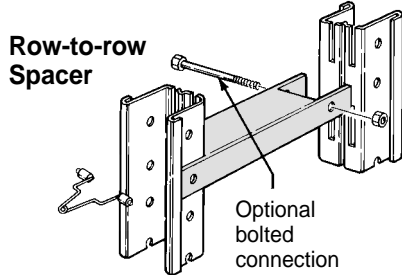

Other Ridg-U-Rak Storage Systems



Horizontal Pallet Transfer System

High density, deep flow system provides smooth, positive mechanical pallet movement - eliminates the problems common to gravity flow systems. Also available are push-bak™, drive-in, mobile, double-deep and other high density storage systems.



Pick Module Storage Systems

Provides high throughput in order fulfillment and storage operations. Custom designed to meet your specific needs and available on a turnkey installation basis from Ridg-U-Rak.



Storage Systems and Capabilities

What storage method is best for your particular needs? Request Manual 25 and review over 20 different proven methods of high productivity storage. Phone or FAX today.

How to Order

To order, or for more information, call and talk to our specially trained inside sales team. Or for hometown service, call your local Ridg-U-Rak Distributor listed in the Yellow Pages.

Phone: **814-725-8751** Fax: **814-725-5659**
www.ridgurak.com



Famous for integrity for over 50 years

Proud member
of these organizations



MEMBER COMPANY

Incorporated in 1945, The Material Handling Institute is a national trade association of material handling equipment manufacturers dedicated to promoting the proper and effective use of their equipment and services.

MEMBER COMPANY



RACK MANUFACTURERS INSTITUTE

The Rack Manufacturers Institute, organized in 1958, represents the majority of U.S. rack manufacturers and is dedicated to maintaining rack performance standards.



MHEDA is a professional organization dedicated to further educating, improving the proficiency and enhancing the professional image of material handling distributors nationwide.

Ridg-U-Rak is a proud member in good standing of RMI. The Storage Rack covered by this manual is in full compliance with the latest design specification approved by the members of the RACK MANUFACTURERS INSTITUTE. We believe that it is important to you that your supplier be committed to the principles of continuous improvement in both product design/application, and in the highest professional and ethical standards of performance as embodied in the mission and work conducted within RMI.